



voorgevel pand F

schaal 1:200



achtergevel pand F - G

schaal 1:200

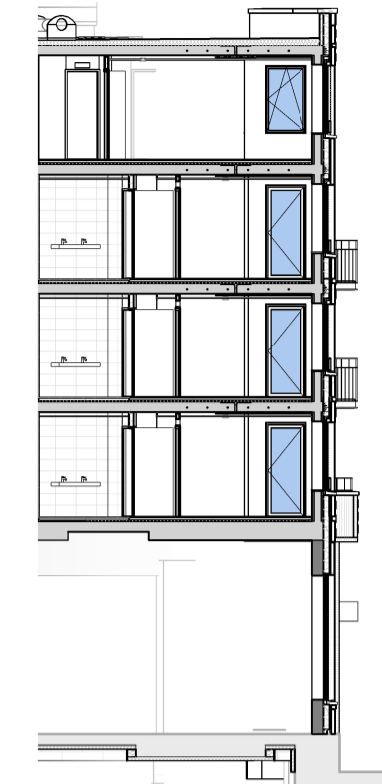

doorsnede pand F (fragment A)

schaal 1:200

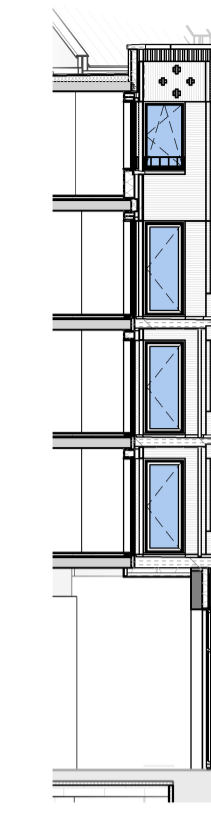

doorsnede pand F (fragment B)

schaal 1:200



doorsnede pand F (fragment C)

schaal 1:200

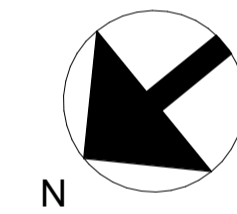
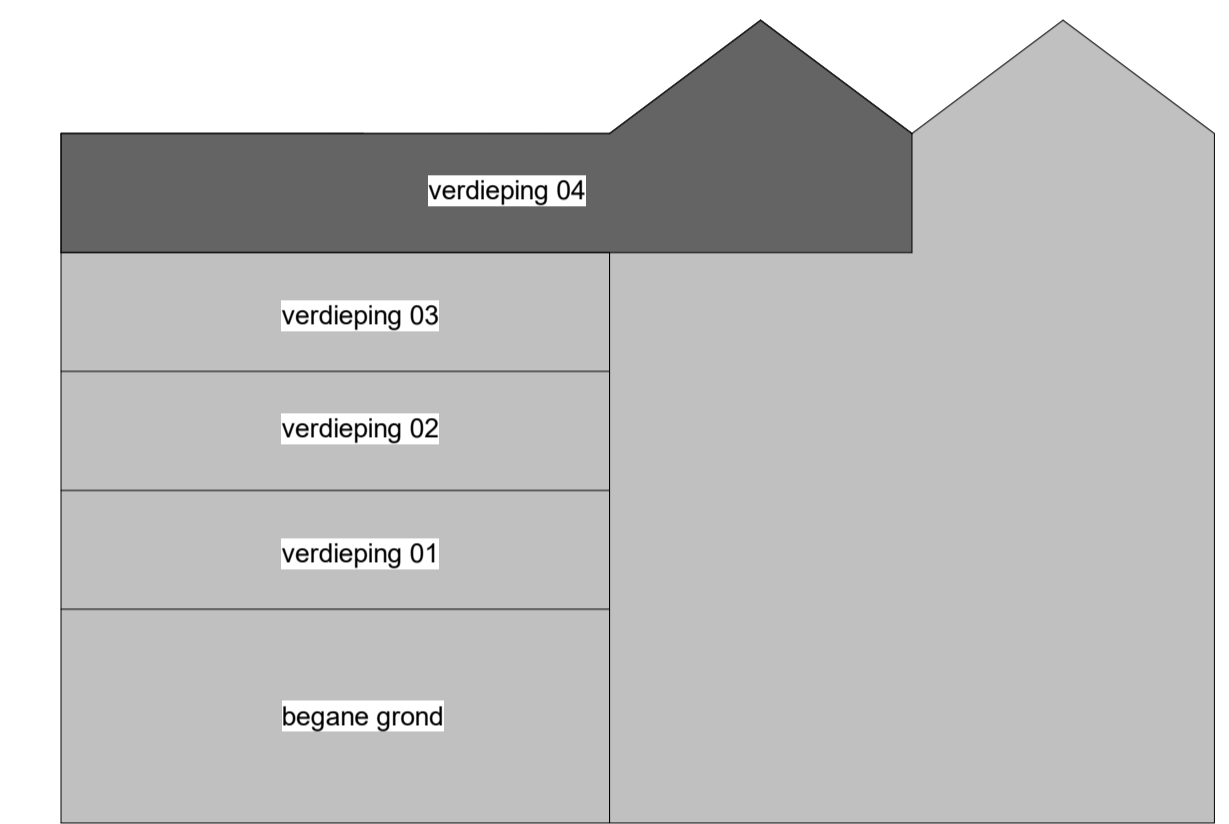

WONINGPEIL P=0 = 6360+ NAP

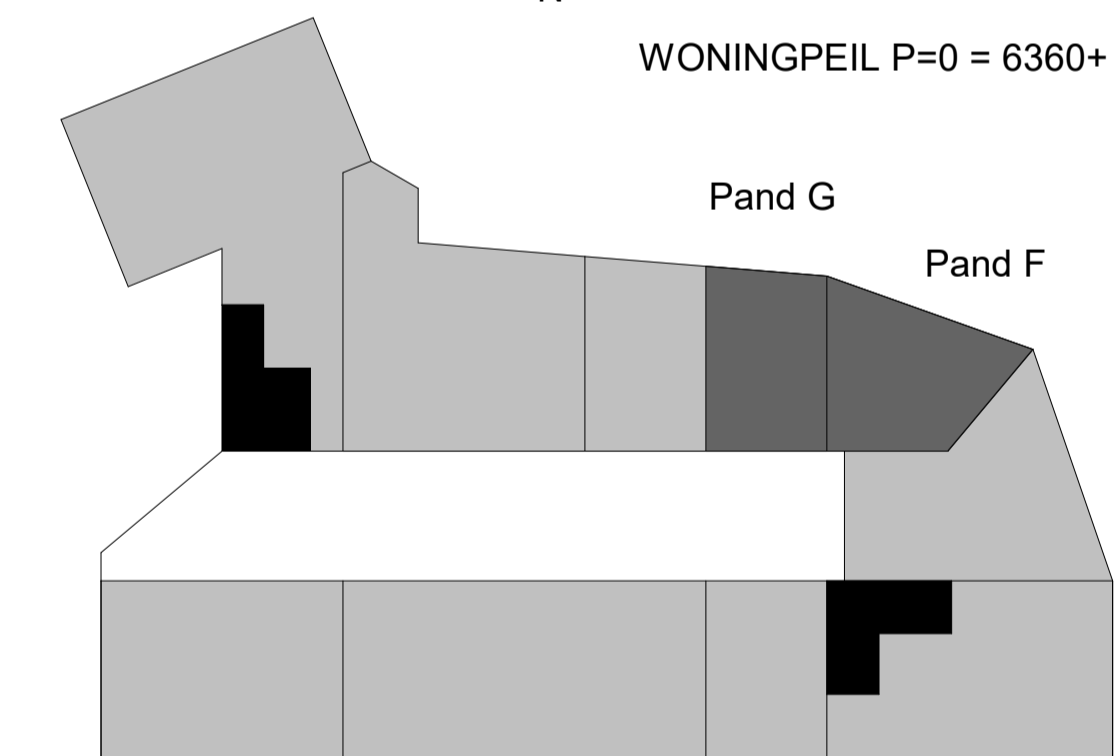

schaal 1:200

schaal 1:50

Genoemde maten zijn circa maten en in centimeters  
Trappen indicatief

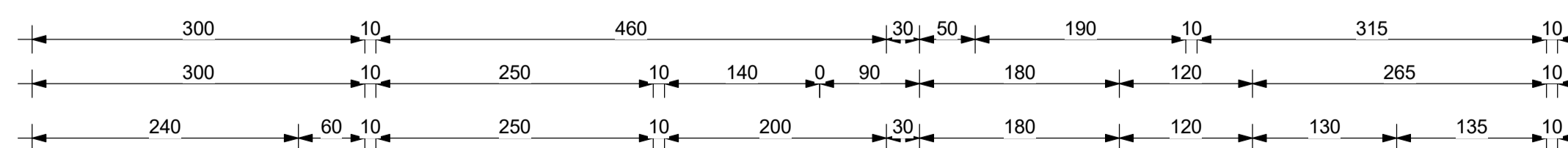
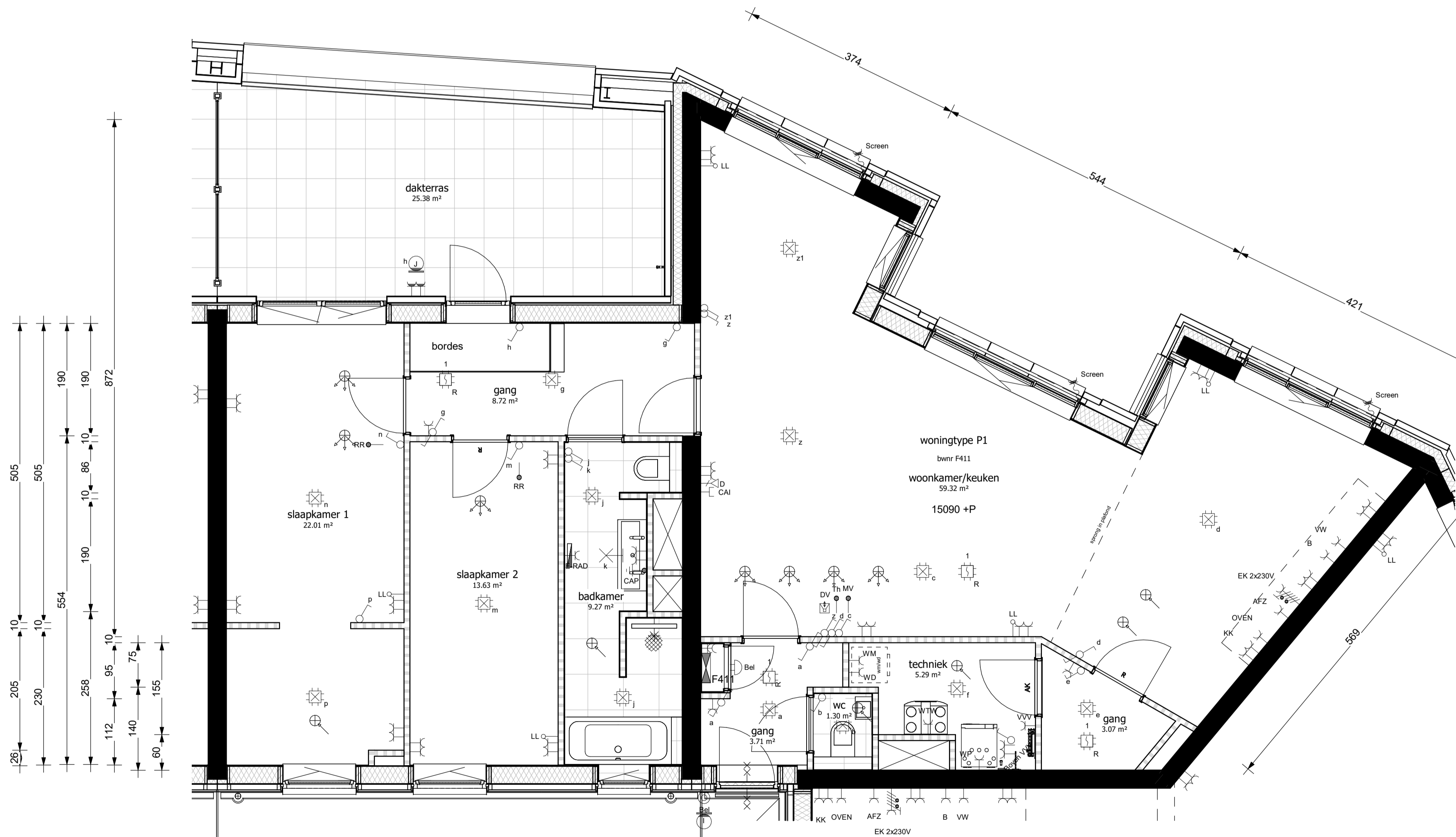

bouwnummer F411

schaal 1:50



Project  
Gasthuiskwartier F  
's-Hertogenbosch

Blad  
verkooptekening - bouwnummer F411

formaat  
A1

Datum  
20-04-2023

Wijziging

Schaal  
variabel

Status

Blad  
1 van 1

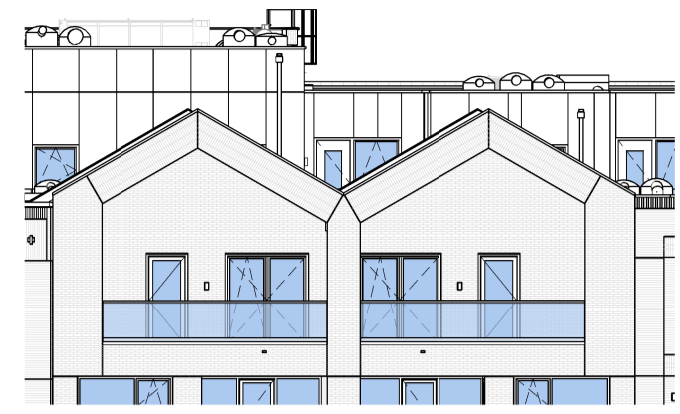

voorgevel pand G (vierde verdieping)

schaal 1:200



voorgevel (fragment A)

schaal 1:200



voorgevel (fragment B)

schaal 1:200

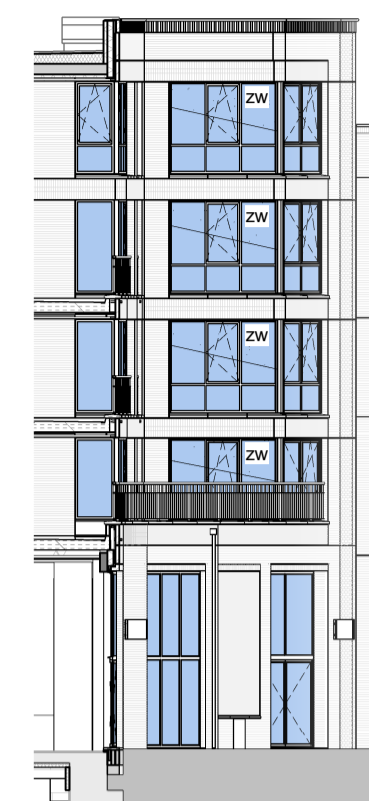

voorgevel (fragment C)

schaal 1:200



doorsnede B pand G

schaal 1:200

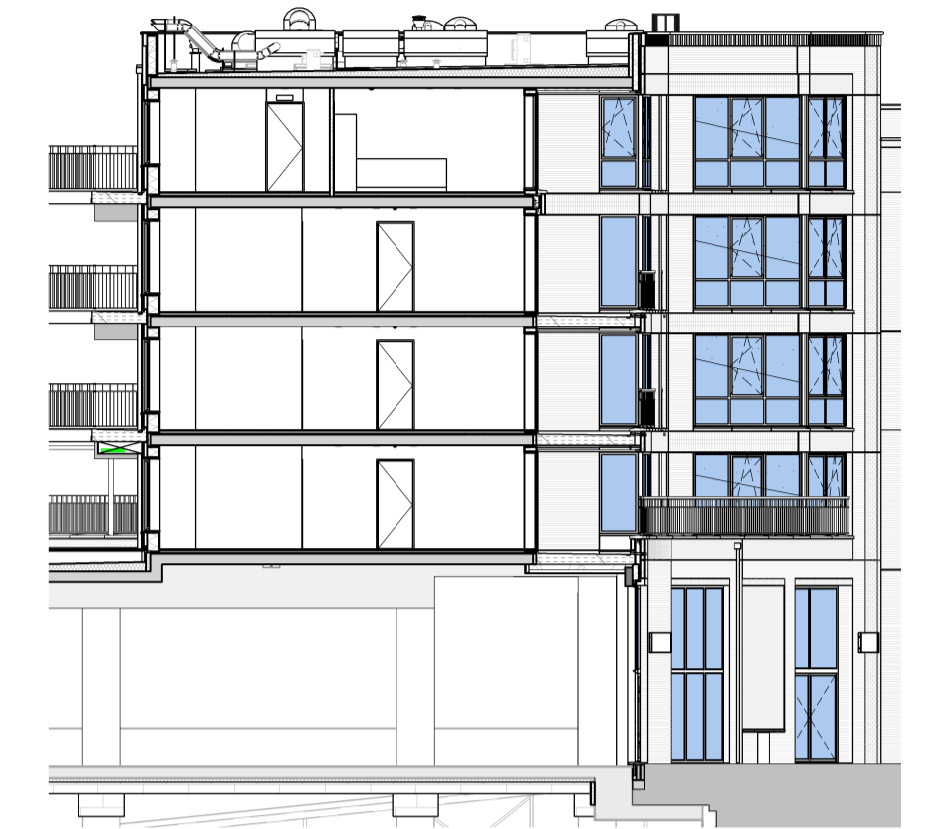

doorsnede A pand H

schaal 1:200

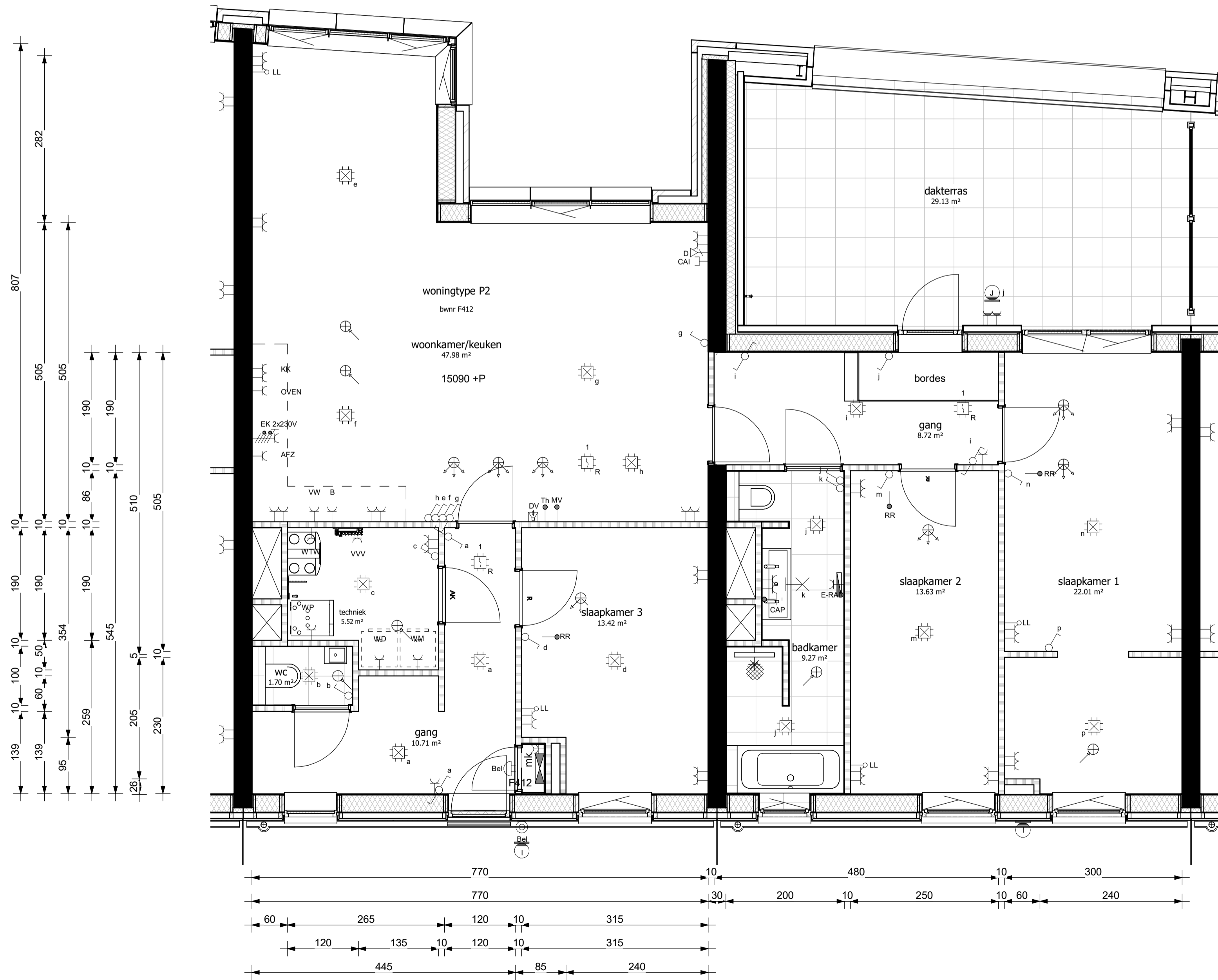

bouwnummer F412

schaal 1:50

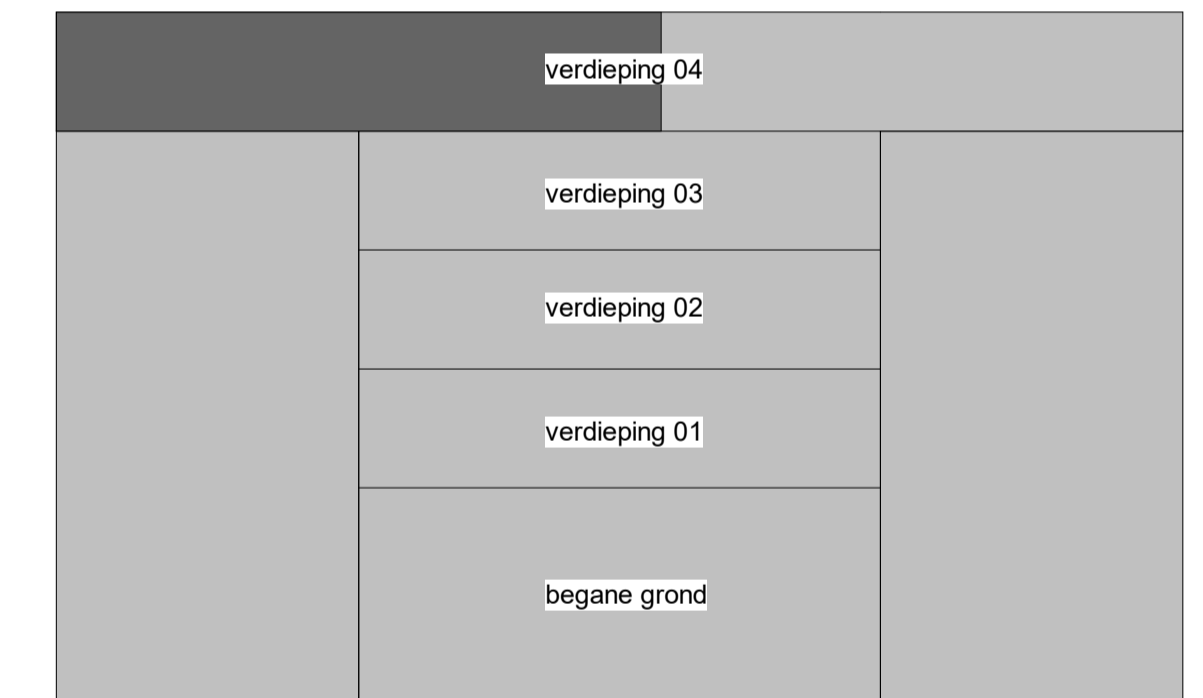
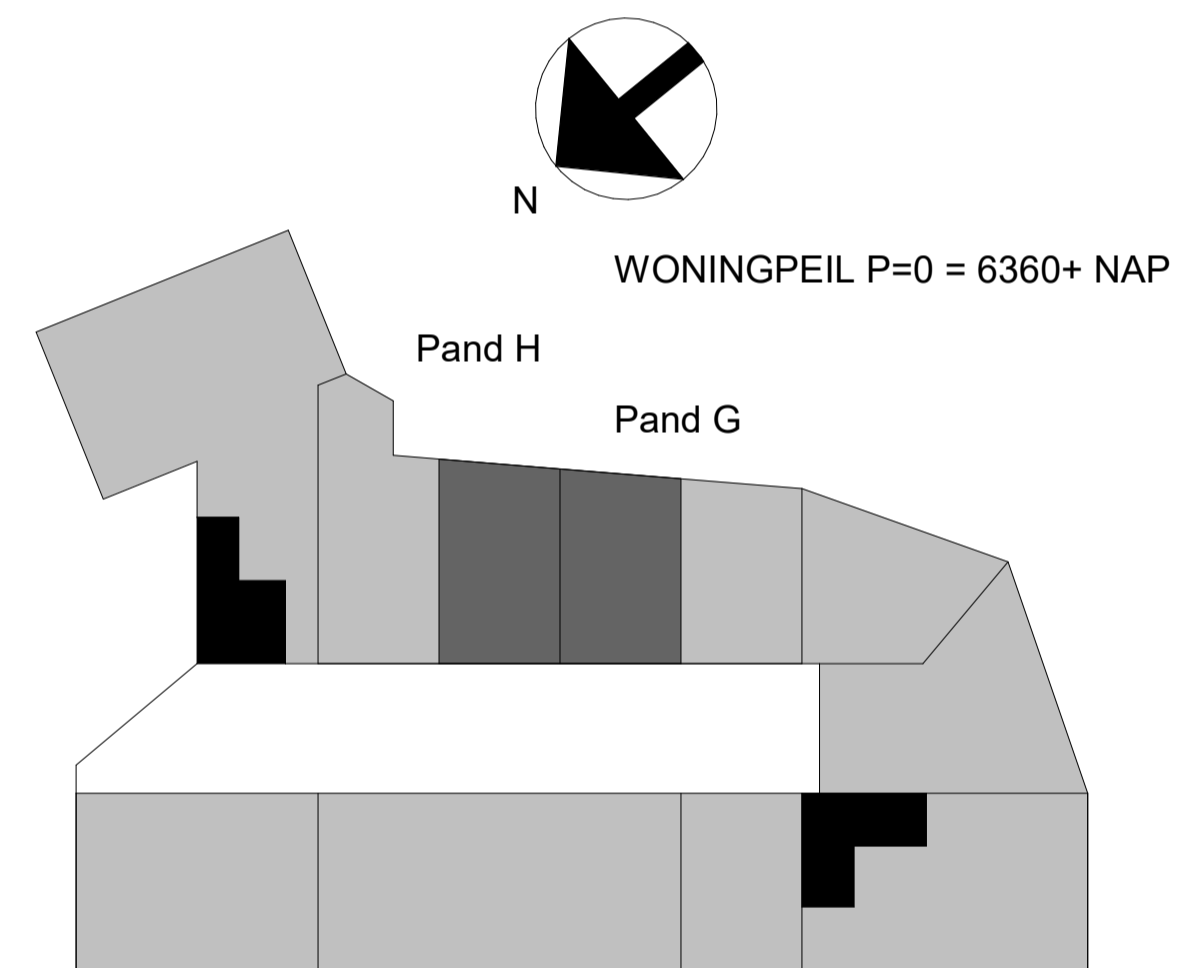

schaal 1:200

schaal 1:50

Genoemde maten zijn circa maten en in centimeters

Trappen indicatief



Project  
Gasthuiskwartier F  
's-Hertogenbosch

Blad  
verkooptekening - bouwnummer F412

formaat  
A1

Datum  
20-04-2023

Wijziging

Schaal  
variabel

Status

Blad  
1 van 1

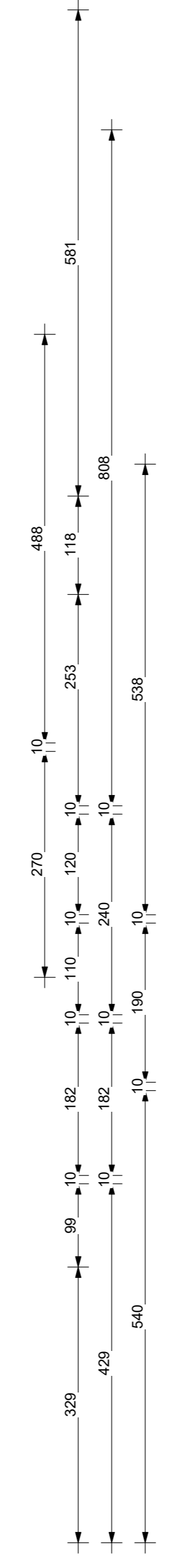
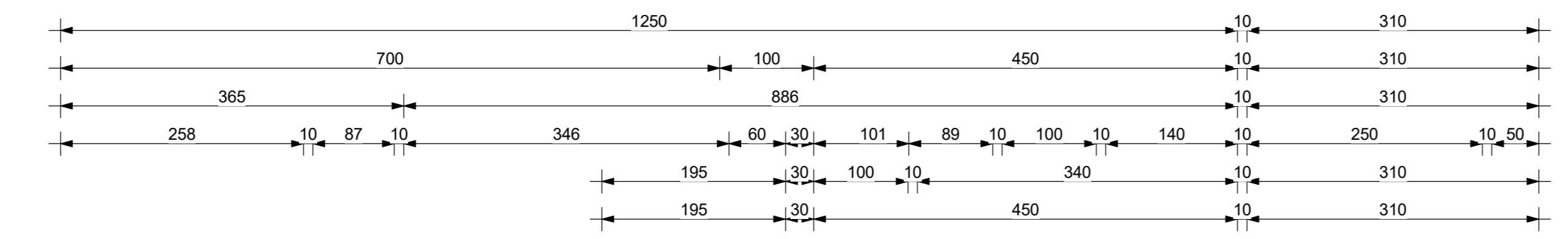
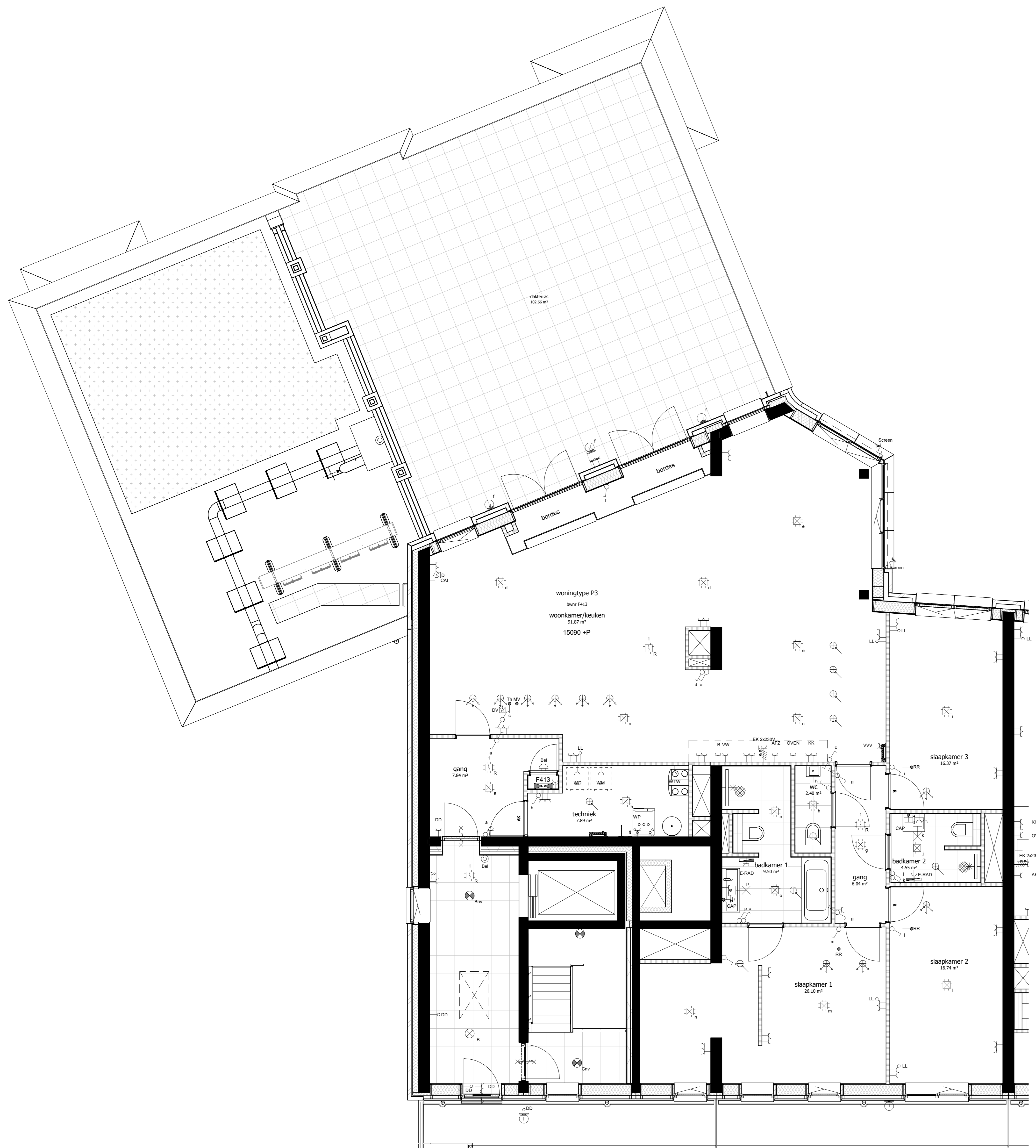

bouwnummer F413  
schaal 1:50



voorgevel (fragment A)  
schaal 1:200



voorgevel (fragment B)  
schaal 1:200



voorgevel (fragment C)  
schaal 1:200

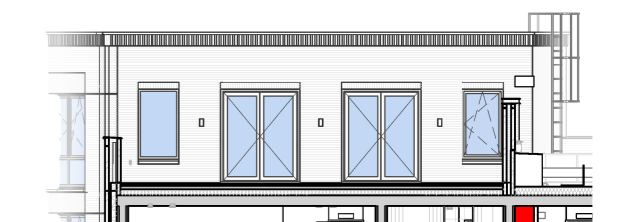

voorgevel pand H (boven I)  
schaal 1:200

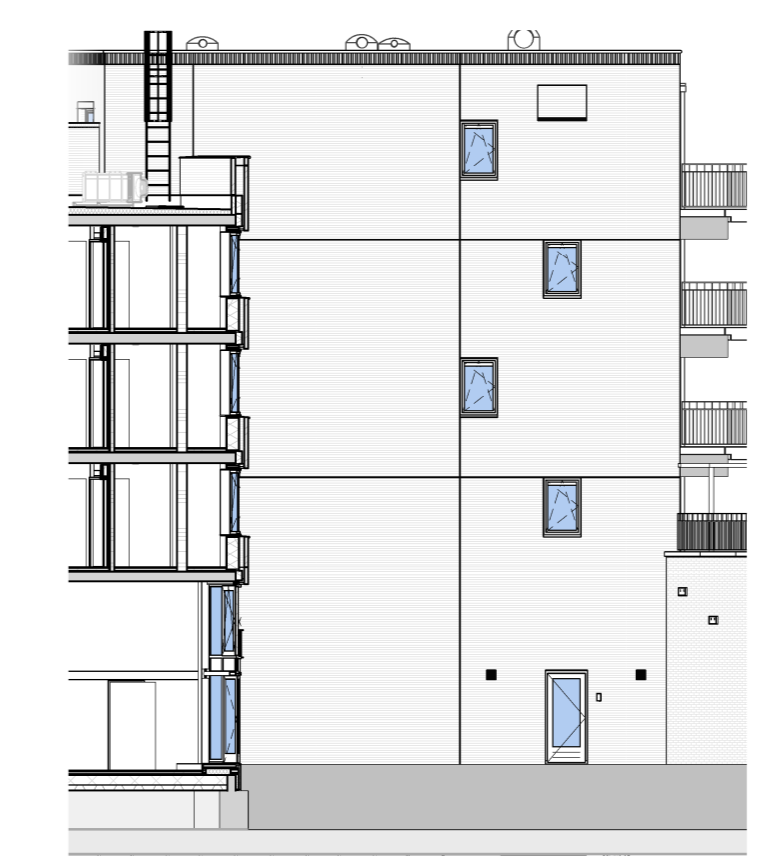

zijgevel pand H  
schaal 1:200

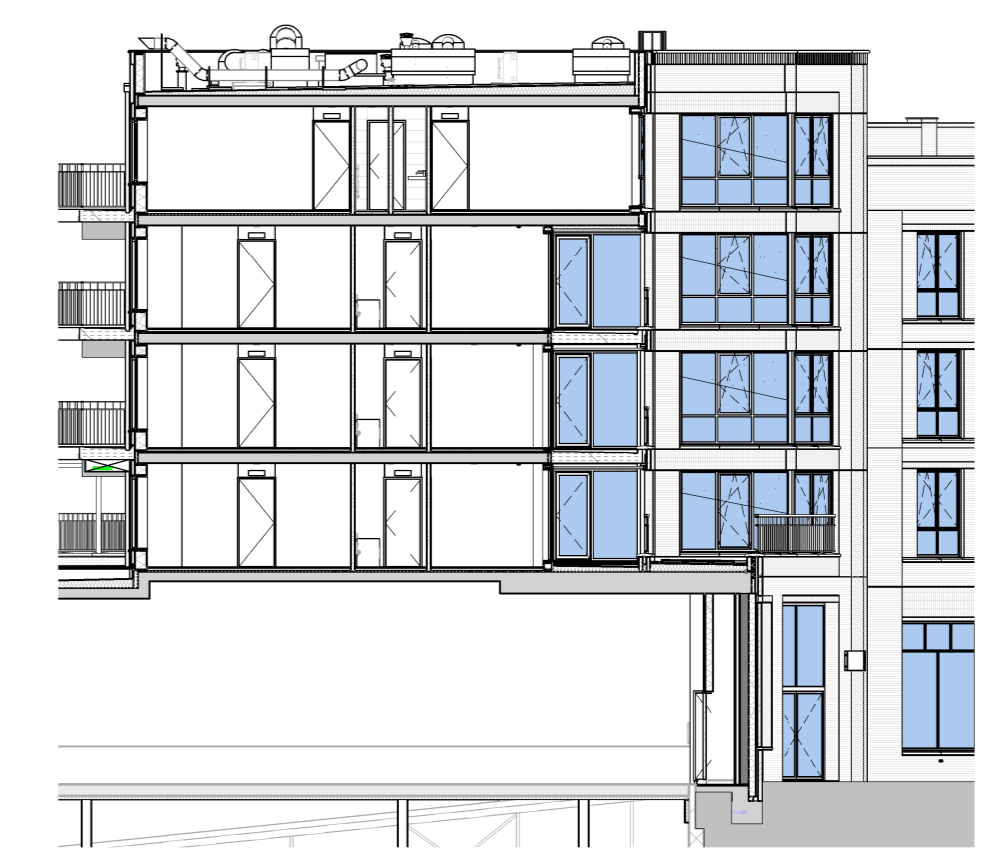

doorsnede B pand H  
schaal 1:200

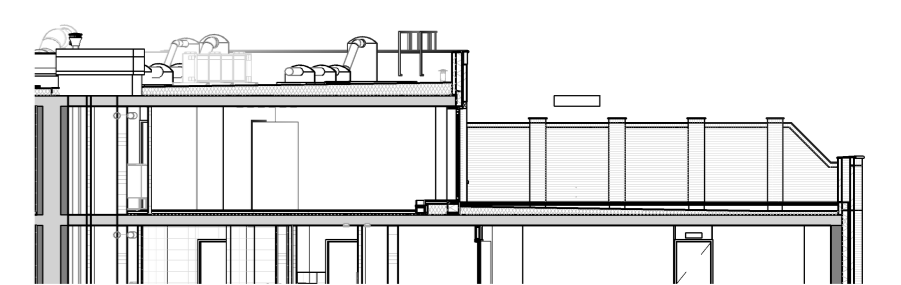

fragment pand H (boven I)  
schaal 1:200

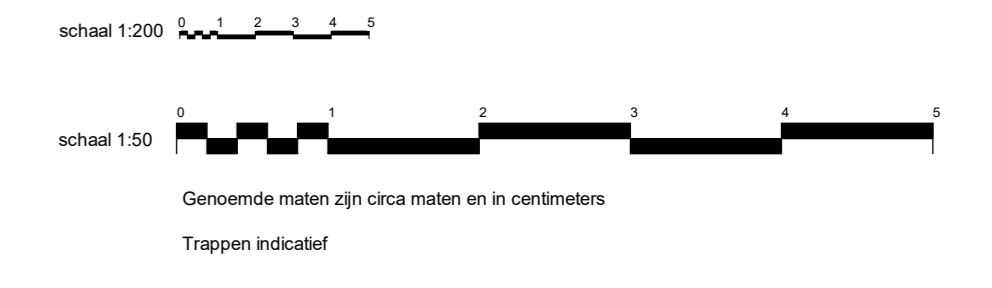
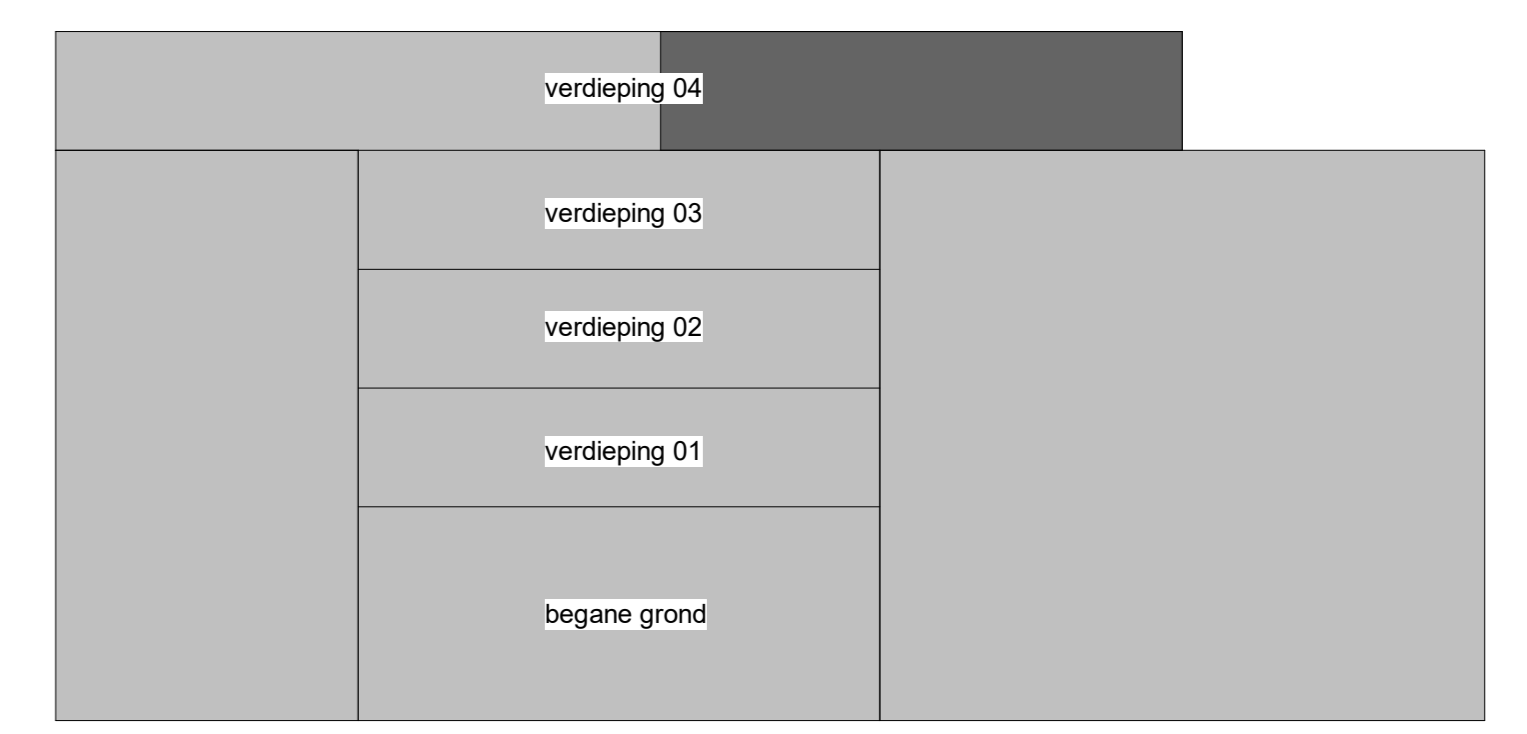
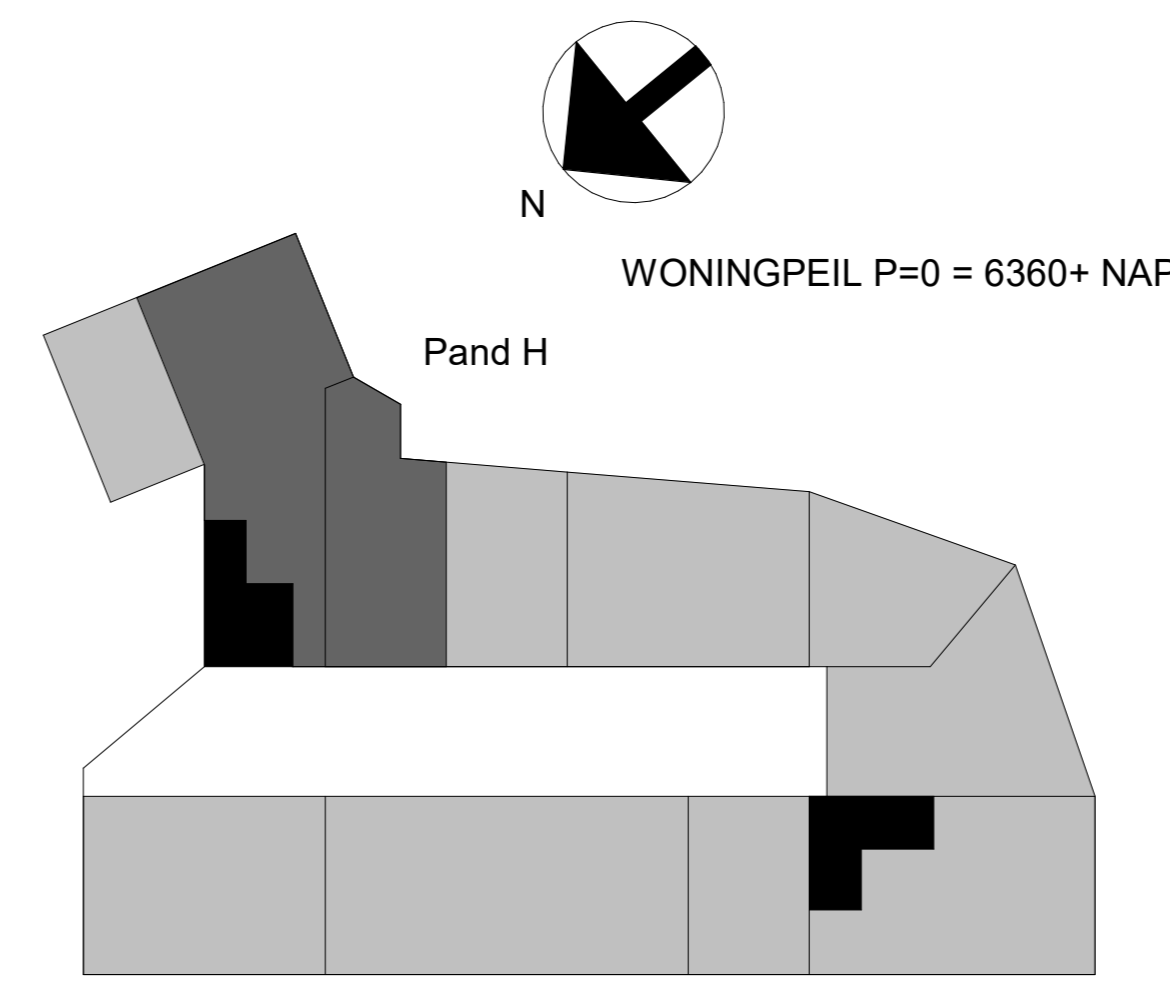



voorgevel pand B



achtergevel pand B



doorsnede B

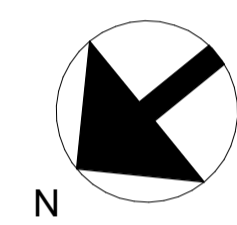
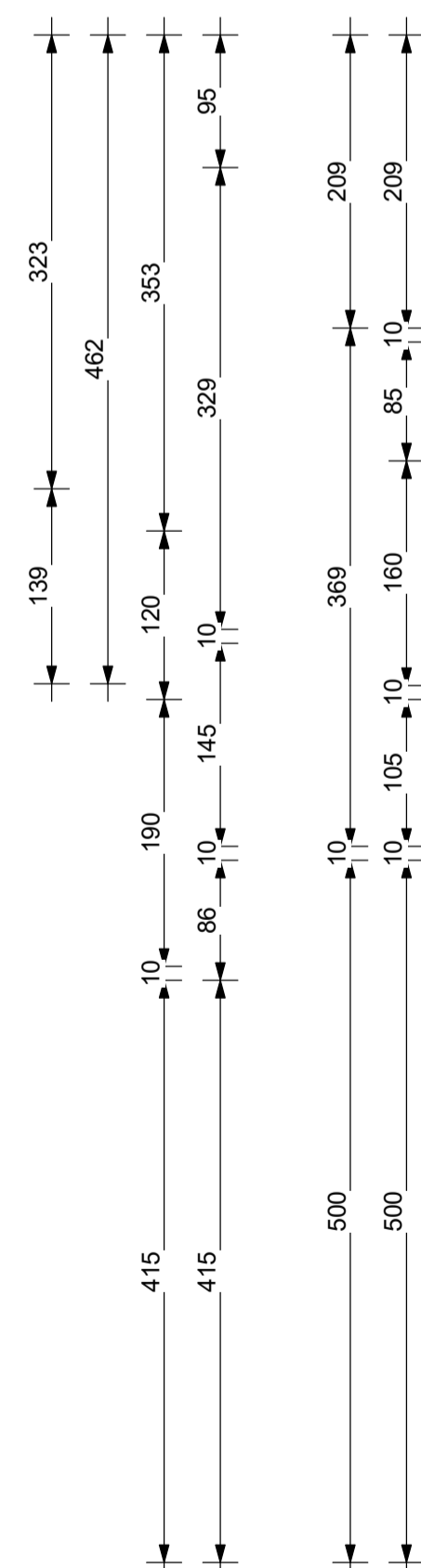
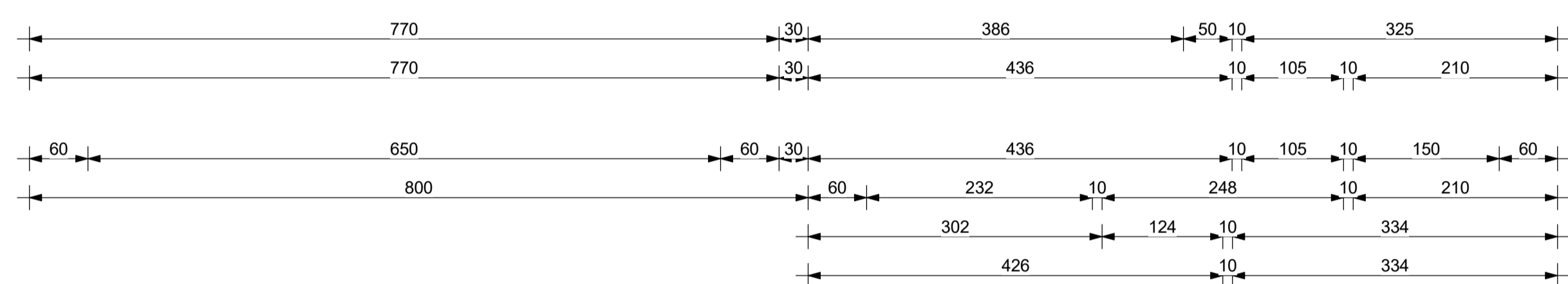

WONINGPEIL P=0 = 6360+ NAP

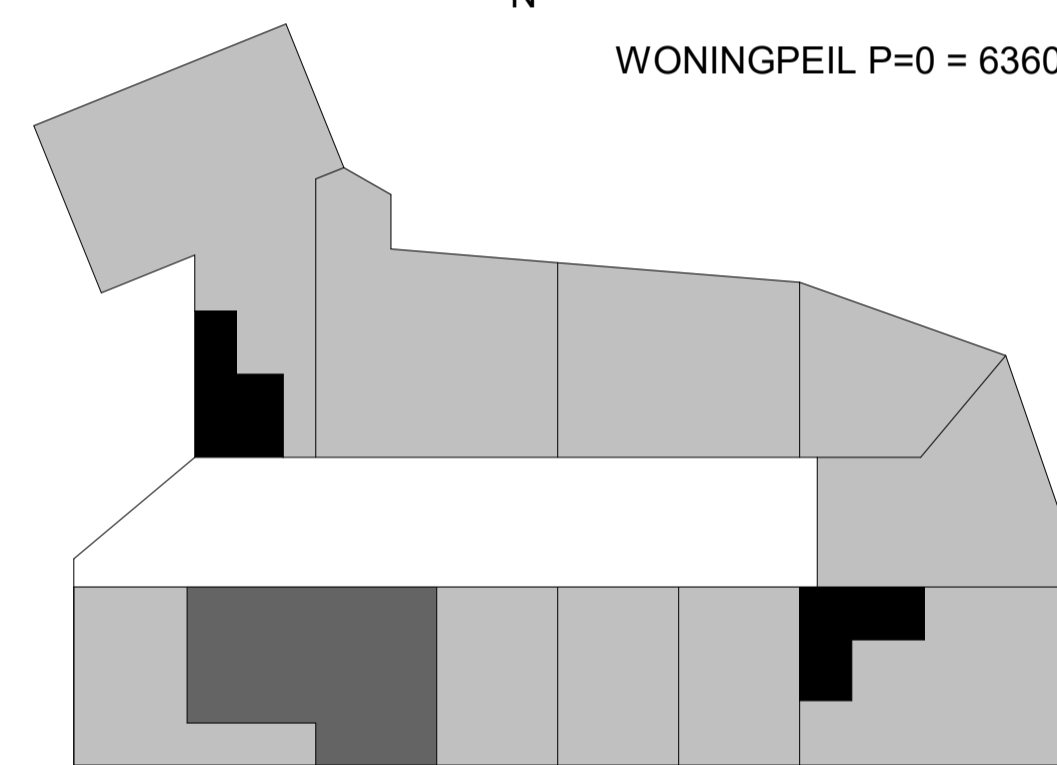

Pand A Pand B

	verdieping 05
	verdieping 04
	verdieping 03
	verdieping 02
	verdieping 01
	begane grond

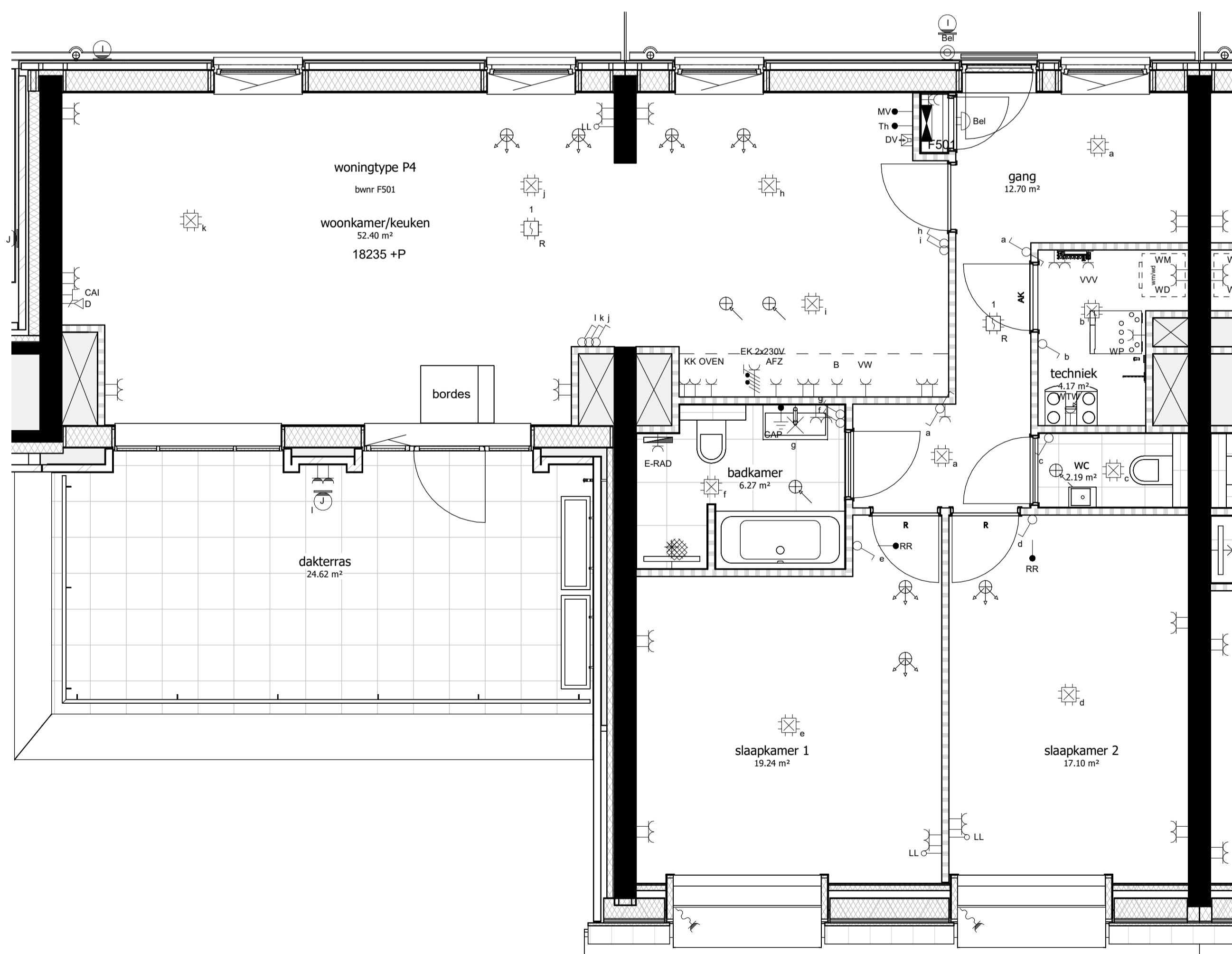

bouwnummer F501

schaal 1 : 50

schaal 1:200 0 1 2 3 4 5

schaal 1:50 0 1 2 3 4 5

Genoemde maten zijn circa maten en in centimeters

Trappen indicatief



Project  
Gasthuiskwartier F  
's-Hertogenbosch

Blad  
verkooptekening - bouwnummer F501

formaat  
A1

Datum  
20-04-2023

Wijziging

Schaal  
variabel

Status

Blad  
1 van 1



voorgevel pand D



rechter zijgevel pand D

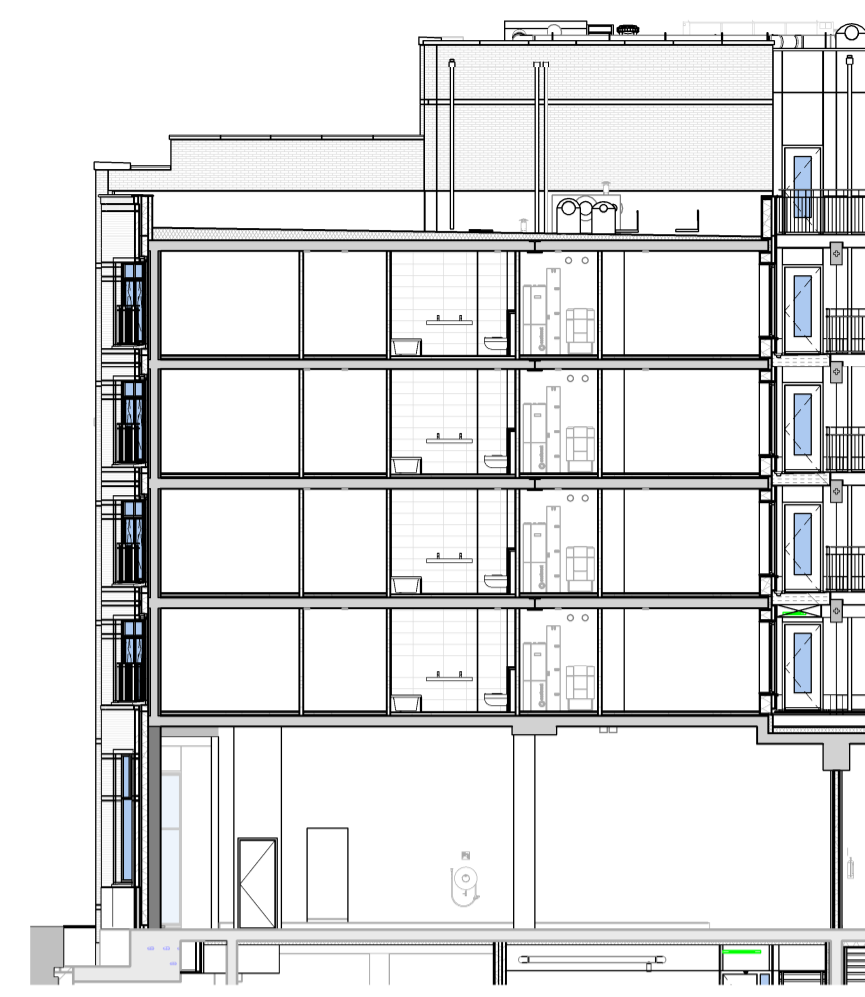

achtergevel pand D



doorsnede D

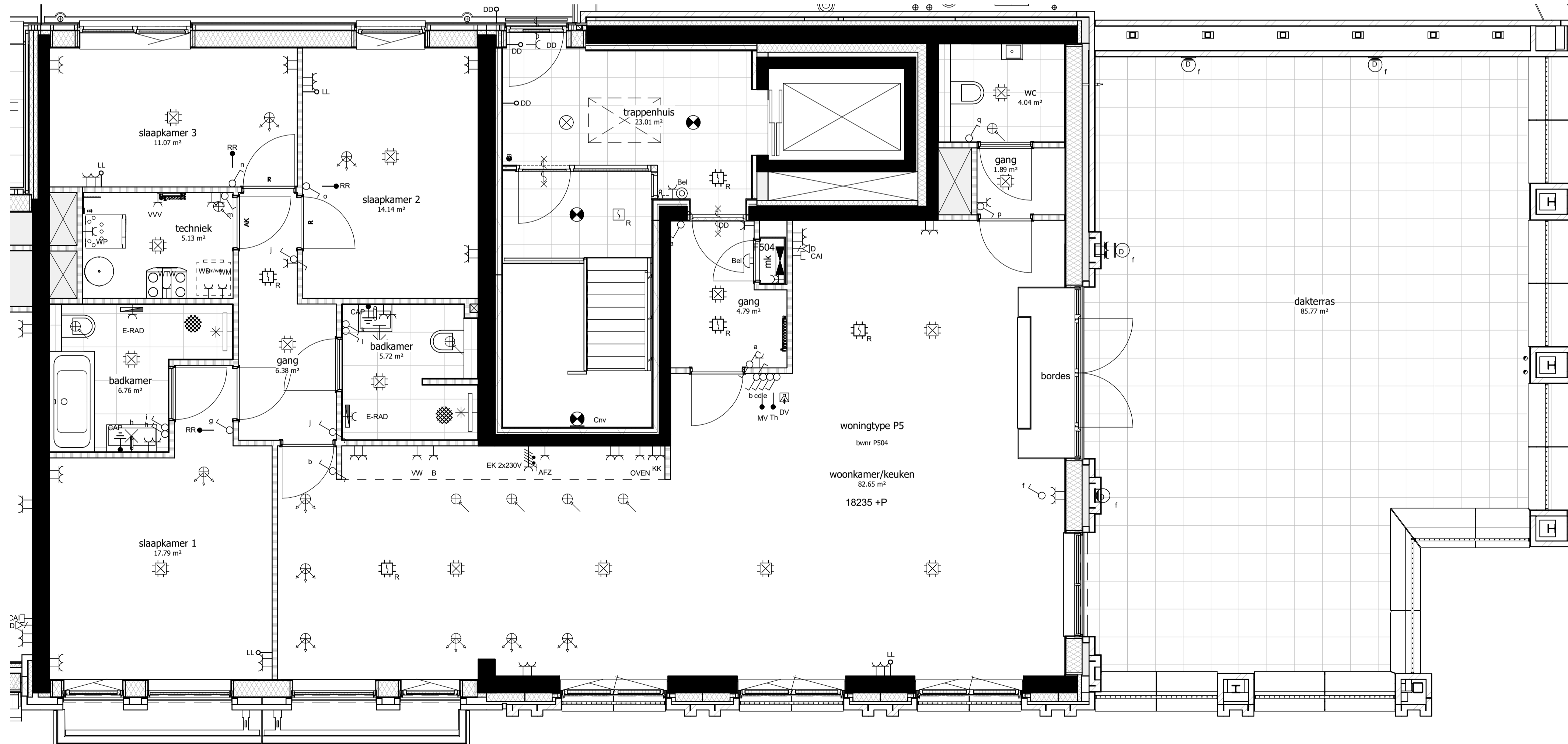
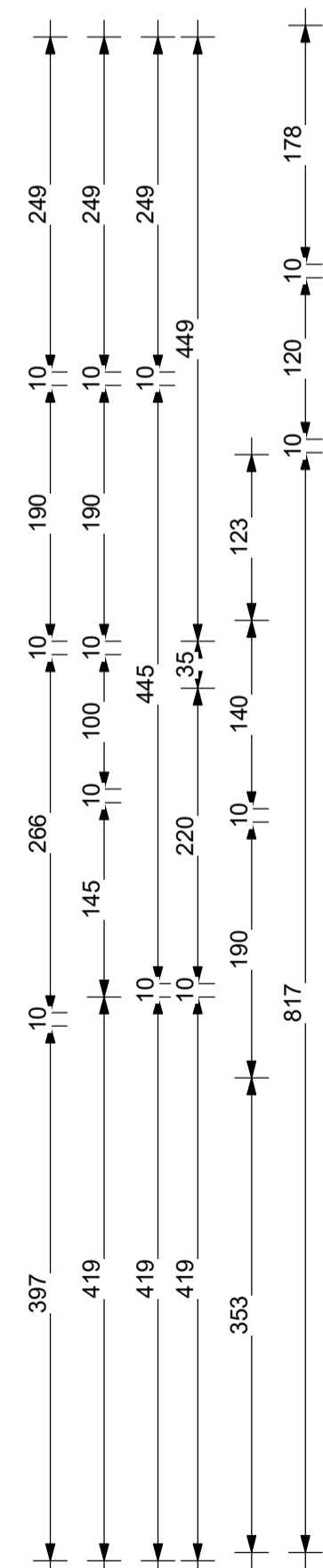
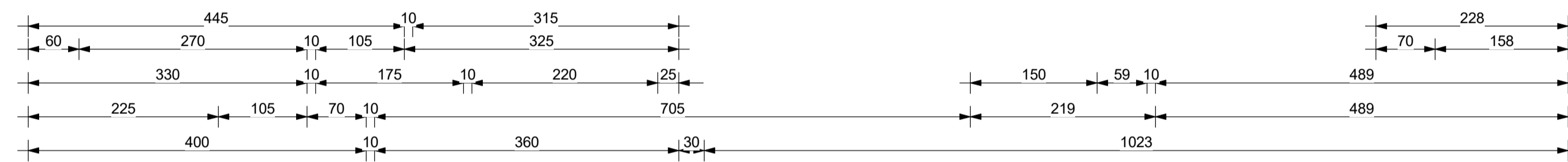

bouwnummer F504

schaal 1 : 50

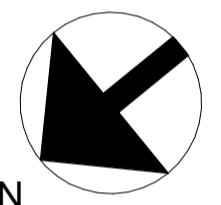
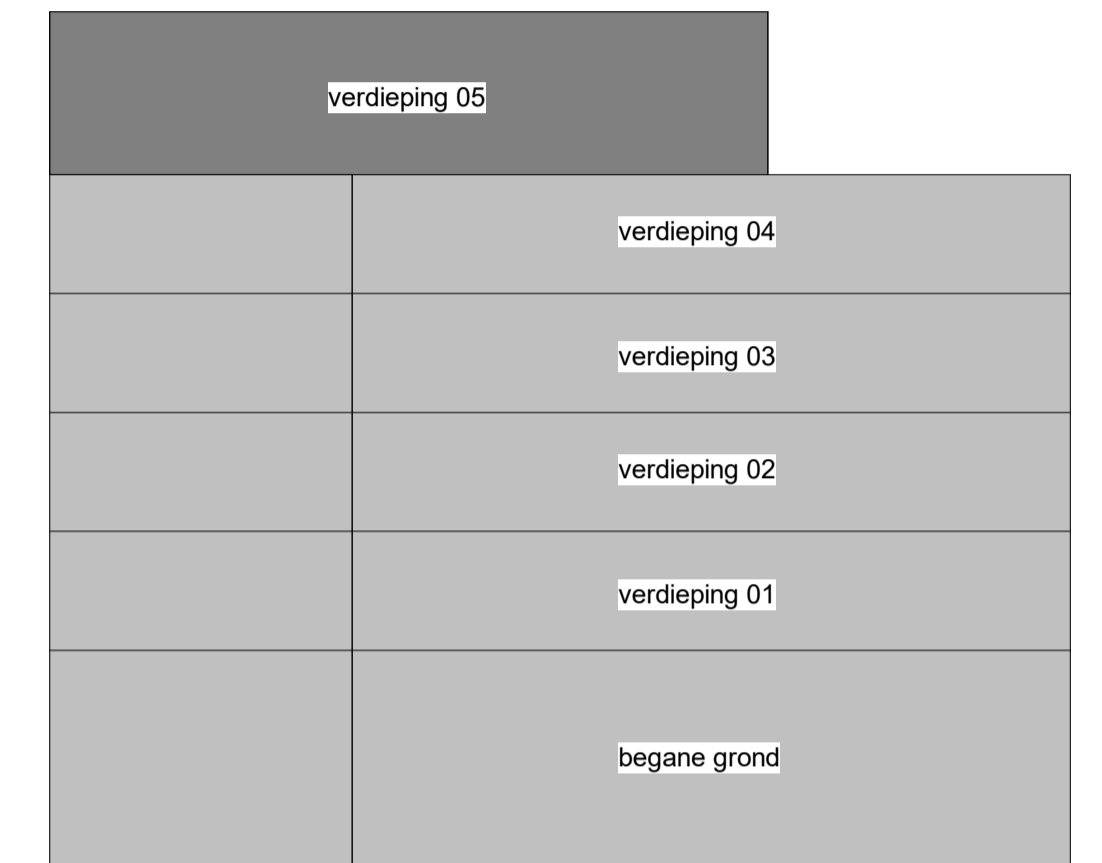

WONINGPEIL P=0 = 6360+ NAP

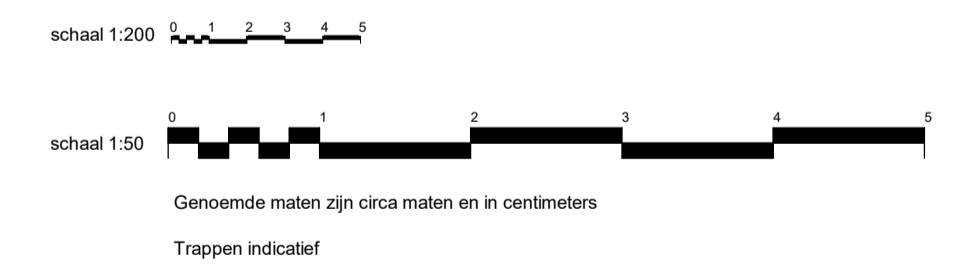
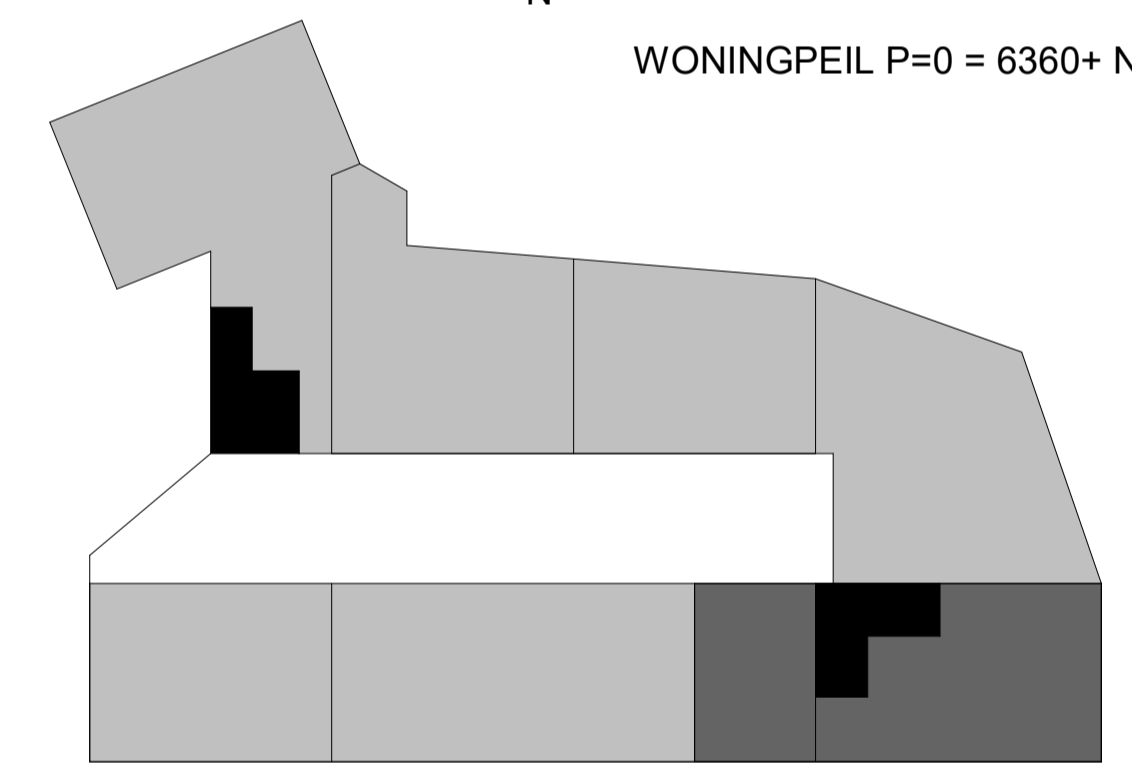

Project  
**Gasthuiskwartier F**  
 's-Hertogenbosch

Blad  
 verkooptekening - bouwnummer F504

formaat  
 A1

Datum  
 20-04-2023

Schaal  
 variabel

Status

Wijziging

Blad  
 1 van 1